

LAVATHERM 58840R

User manual

Condenser Dryer with
Rack

Dear Customer

Thank you for choosing one of our high-quality products.

With this appliance you will experience the perfect combination of functional design and cutting edge technology.

Convince yourself that our appliances are engineered to deliver the best performance and control - indeed we are setting the highest standards of excellence.

In addition to this you find environmental and energy saving aspects as an integral part of our products.

To ensure optimal and regular performance of your appliance please read this instruction manual carefully. It will enable you to navigate all processes perfectly and most efficiently. To refer to this manual any time you need to, we recommend you to keep it in a safe place. And please pass it to any future owner of the appliance.

We wish you much joy with your new appliance.

The following symbols are used in this user manual:



Important information concerning your personal safety and information on how to avoid damaging the appliance.



General information and tips



Environmental information

Contents

Operating Instructions	5
Important safety information	5
Product description	8
Control panel	9
What is shown in the display	10
Before first use	10
Sorting and preparing laundry	10
Programme overview	12
Daily use	16
Switching machine on / switching light on	16
Opening loading door / loading laundry	16
Selecting the programme	16
Setting dryness level	17
Setting the pre-drainage spin speed	17
Selecting additional options	17
DELICATE	18
LONG ANTI-CREASE	19
SENSITIVE	19
BUZZER	19
Time	20
Setting delay timer	20
Setting child lock	20
Starting the programme	21
Changing programme	21
Putting in extra items or taking items out before end of programme	22
Drying cycle complete / removing laundry	22
Drying rack	23
Care and cleaning	25
Cleaning fluff filter	25
Cleaning the door seal	27
Emptying the condensate tank	27
Cleaning heat exchanger	28

Cleaning the drum	29
Clean operating screen and housing	30
What to do if ...	31
Troubleshooting by yourself	31
Changing the bulb for interior lighting	33
Machine settings	34
Technical data	35
Consumption values	35
Hints for test institutes	36
Installation	36
Appliance positioning	36
Removing transport safety packaging	37
Drying rack unpacking	37
Electrical connection	38
Changing door stop	38
Special accessories	40
Environment	41
Packaging material	41
Old appliance	41
Environmental tips	42
Service	43

Operating Instructions

Important safety information



In the interest of your safety and to ensure the correct use, before installing and first using the appliance, read this user manual carefully, including its hints and warnings. To avoid unnecessary mistakes and accidents, it is important to ensure that all people using the appliance are thoroughly familiar with its operation and safety features. Save these instructions and make sure that they remain with the appliance if it is moved or sold, so that everyone using it through its life will be properly informed on appliance use and safety.

General safety

- It is dangerous to alter the specifications or attempt to modify this product in any way.
- This appliance is not intended for use by persons (including children) with reduced physical, sensory or lack of experience and knowledge, unless they have been given supervision or instruction concerning use of the appliance by a person responsible for their safety.
- Make sure that small pets do not climb into the drum. To avoid this, please check into the drum before using.
- Any objects such as coins, safety pins, nails, screws, stones or any other hard, sharp material can cause extensive damage and must not be placed into the machine.
- In order to avoid danger of fires caused by excessive drying, do not use appliance to dry the following items: Cushions, quilts and the like (these items accumulate heat).
- Items such as foam rubber (latex foam), shower caps, waterproof textiles, rubber backed articles and clothes or pillows fitted with foam rubber pads should not be dried in the tumble dryer.
- Always unplug the appliance after use, clean and maintenance.
- Under no circumstances should you attempt to repair the machine yourself. Repairs carried out by inexperienced persons may cause injury or serious malfunctioning. Contact your local Service Centre. Always insist on genuine spare parts.

- Items that have been soiled with substances such as cooking oil acetone, petrol, kerosene, spot removers, turpentine, waxes and wax removers should be washed in hot water with an extra amount of detergent before being dried in the tumble dryer.
- **Danger of explosion:** Never tumble dry items that have been in contact with inflammable solvents (petrol, methylated spirits, dry cleaning fluid and the like). As these substance are volatile, they could cause an explosion. Only tumble dry items washed with water.
- **Risk of fire:** items that have been spotted or soaked with vegetable or cooking oil constitute a fire hazard and should not be placed in the tumble dryer.
- If you have washed your laundry with stain remover you must execute an extra rinse cycle before loading your tumble dryer.
- Please make sure that no gas lighters or matches have accidentally been left in pockets of garments to be loaded into appliance



WARNING!

Never stop a tumble dry before the end of the drying cycle unless all items are quickly removed and spread out so that the heat is dissipated.

Installation

- This appliance is heavy. Care should be taken when moving it.
- When unpacking the appliance, check that it is not damaged. If in doubt, do not use it and contact the Service Centre.
- All packing and transit bolts must be removed before use. Serious damage can occur to the product and to property if this is not adhered to. See relevant section in the user manual.
- The final part of a tumble dryer cycle occurs without heat (cool down cycle) to ensure that the items are left at a temperature that ensures that items will not be damaged.
- Any electrical work required to install this appliance should be carried out by a qualified electrician or competent person.
- Care must be taken to ensure that the appliance does not stand on the electrical supply cable.
- If the machine is situated on a carpeted floor, please adjust the feet in order to allow air to circulate freely.
- After having installed the appliance, check that it is not pressing or standing on its electrical supply cable.

- If the tumble dryer is placed on top of a washing machine, it is compulsory to use the stacking kit (optional accessory).

Use

- This appliance is designed for domestic use. It must not be used for purposes other than those for which it was designed.
- Only wash fabrics which are designed to be machine dried. Follow the instructions on each garment label.
- Do not dry unwashed items in the tumble dryer.
- Do not overload the appliance. See the relevant section in the user manual.
- Clothes which are dripping wet should not be placed in the dryer.
- Garments which have been in contact with volatile petroleum products should not be machine dried. If volatile cleaning fluids are used, care should be taken to ensure that the fluid is removed from the garment before placing in the machine.
- Never pull the power supply cable to remove the plug from the socket; always take hold of the plug itself.
- Never use the tumble dryer if the power supply cable, the control panel, the working surface or the base are damaged so that the inside of the tumble dryer is accessible.
- Fabric softeners, or similar products should be used as specified by the fabric softener instructions.
- **Caution - hot surface** : Do not touch the door light cover surface when the light is switched on.¹⁾

Child safety

- This machine is not intended for use by young children or infirm persons without supervision.
- Children should be supervised to ensure that they do not play with the appliance.
- The packaging components (e.g. plastic film, polystyrene) can be dangerous to children - danger of suffocation! Keep them out of children's reach.
- Keep all detergents in a safe place out of children's reach.
- Make sure that children or pets do not climb into the drum.

1) Only dryers equipped with internal drum light.

Product description

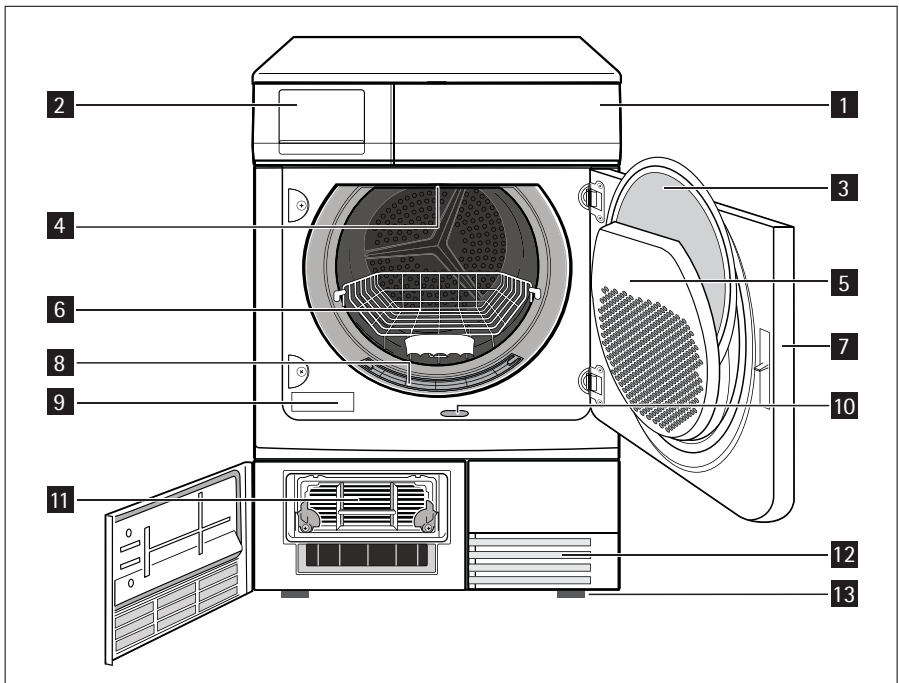

- 1 Control panel
- 2 Drawer with condensed water container
- 3 Fine strainer (lint filter)
- 4 Lamp for inside light
- 5 Large mesh filter (lint filter)
- 6 Drying rack
- 7 Loading door (reversible)
- 8 Micro-fine filter (lint filter)
- 9 Rating plate
- 10 Button for opening door in plinth
- 11 Heat exchanger covered by base door
- 12 Air slots
- 13 Screwed feet (with height adjustment)

Control panel

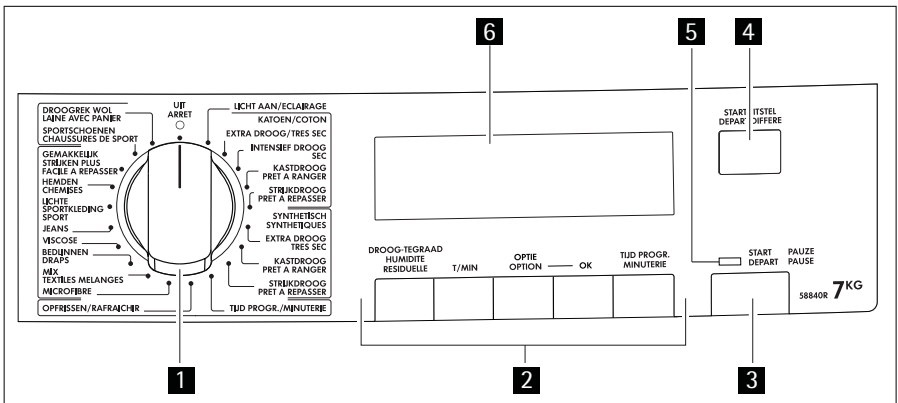

- 1** Programme knob and OFF *UIT* switch
- 2** Function buttons
- 3** START PAUSE / *START PAUZE* button
- 4** DELAY START / *STARTUITSTEL* button
- 5** Status led
- 6** Display

What is shown in the display

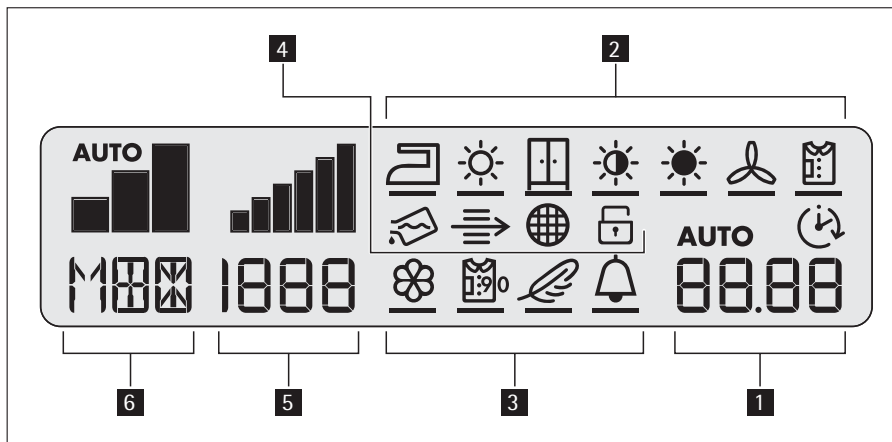

- 1** time to end / error message
- 2** cycle phase status
- 3** options
- 4** warnings
- 5** spin speed selection
- 6** dryness selection

Before first use





In order to remove any residues which may have been produced during production, wipe the dryer drum with a damp cloth or carry out a brief drying cycle (30 MIN) with damp cloths in the machine.

Sorting and preparing laundry

Sorting laundry

- Sort by fabric type:
 - Cotton/linen for programmes in COTTONS *KATOEN* programme group.
 - Mixtures and synthetics for programmes in SYNTHETICS *SYNTHETISCH* programme group.

- Sorting by care label. The care labels mean:

			
Drying in the tumble dryer possible in principle	Drying at normal temperature	Drying at reduced temperature (set DELICATE <i>DELICAAAT</i> option)	Drying in the tumble dryer not possible

 Do not place in the appliance any wet laundry which is not specified on the care label as being suitable for tumble-drying.

This appliance can be used for all wet laundry items which are labelled as suitable for tumble-drying.

- Do not dry new, coloured textiles together with light-coloured laundry items. Textile colours may bleed.
- Do not dry cotton jersey and knitwear with the EXTRA programme. Items may shrink!
- Wool and wool-like textiles can be dried using the WOOL RACK *DROOGREK WOL* programme. Before the drying cycle spin the woollen textiles as well as possible (max. 1200 rpm). Only dry woollen textiles together which are similar or the same with respect to material, colour and weight. Please dry heavy laundry items made of wool separately.

Preparing laundry

- To avoid laundry becoming tangled: close zips, button up duvet covers and tie loose ties or ribbons (e.g. of aprons).
- Empty pockets. Remove metal items (paper clips, safety pins, etc).
- Turn items with double-layered fabrics inside out (e.g. with cotton-lined anoraks, the cotton layer should be outermost). These fabrics will then dry better.

Programme overview

Programmes		max. load (weight when dry)	Additional functions/options								Application/properties	Care mark
			DRYNESS DROOGTEGRAAD	RPM T/MIN	DELICATE ¹⁾	LONG ANTI-CREASE	SENSITIVE ¹⁾	BUZZER	TIME TIJD PROGR.	DELAY START STARTUITSTIEL		
COTTONS KATOEN	EXTRA EXTRA DROOG	7 kg	•	•	•	•	•	•	-	•	Thorough drying of thick or multi-layered fabrics, e.g. terry towelling items, bathrobes.	
	STRONG INTENSIEF DROOG	7 kg	•	•	•	•	•	•	-	•	Thorough drying of thick fabrics, e.g. terry towelling items, towels.	
	CUPBOARD KAST-DROOG	7 kg	•	•	•	•	•	•	-	•	Thorough drying of fabrics of even thicknesses, e.g. terry towelling items, knitwear, towels.	
	IRON STRIJK-DROOG	7 kg	•	•	•	•	•	•	-	•	For thin fabrics which are also to be ironed, e.g. knitwear, cotton shirts.	
SYNTHETICS SYNTHETISCH	EXTRA EXTRA DROOG	3 kg	•	•	•	•	•	•	-	•	Thorough drying of thick or multi-layered fabrics, e.g. pull-overs, bedding, table linen.	
	CUPBOARD KAST-DROOG	3 kg	•	•	•	•	•	•	-	•	For thin fabrics which are not ironed, e.g. easy care shirts, table linen, baby clothes, socks, lingerie with bones or wires.	
	IRON STRIJK-DROOG	3 kg	•	•	•	•	•	•	-	•	For thin fabrics which are also to be ironed, e.g. knitwear, cotton shirts.	
TIME	TIME TIJD PROGR.	7 kg	-	-	•	•	-	•	•	•	For further drying of individual items of laundry or for volumes of less than 7 kg.	

Programmes		max. load (weight when dry)	Additional functions/options							Application/properties	Care mark	
			DRYNESS DROOGTEGRAAD	RPM T/MIN	DELICATE 1)	LONG ANTI-CREASE SENSITIVE 1)	BUZZER	TIME TIJD PROGR.	DELAY START STARTUITSTEL			
SPECIAL	FRESHEN UP <i>OPFRISSEN</i>	1 kg	-	-	•	•	-	•	-	•	For refreshing or gently cleaning textiles with commercially available dry cleaning products.	
	MICRO-FIBER <i>MI-CROFIBRE</i>	1 kg	•	•	• ³⁾	•	-	•	-	•	For thin fabrics, polyester and polyamide, which are not ironed.	
	MIXED <i>MIX</i>	3 kg	•	•	• ³⁾	•	-	•	-	•	For drying cotton and synthetic fabrics, uses low temperature.	
	BED LINEN <i>BEDLINNEN</i>	3 kg	•	•	•	•	-	•	-	•	Bed linen (single and double sheet, pillowcase, bedspread, duvet cover).	
	VISCOSE	1 kg	•	•	• ³⁾	•	-	•	-	•	For thin fabrics, viscose, and polyester, which are not ironed.	
	JEANS	7 kg	•	•	•	•	•	•	-	•	For leisure clothing, such as jeans, sweat-shirts, etc., of different material thicknesses (e.g. at the neck, cuffs and seams).	
	SPORTS LIGHT <i>LICHTE SPORTKLEDING</i>	2 kg	•	•	• ³⁾	•	-	•	-	•	For sportswear, thin fabrics, polyester, which are not ironed.	

Programmes		max. load (weight when dry)	Additional functions/options							Application/properties	Care mark	
			DRYNESS DROOGTEGRAAD	RPM T/MIN	DELICATE 1)	LONG ANTI-CREASE	SENSITIVE 1)	BUZZER	TIME TIJD PROGR.			DELAY START STARTUITSTIEL
	SHIRTS <i>HEMDEN</i>	1.5 kg (or 7 shirts)	•	•	• 3)	•	-	•	-	•	Special program with anti-crease mechanism for easy care fabrics such shirts and blouses; for minimum ironing effort. The results depends on the type of fabric and its finish. Place fabrics in the dryer straight after spinning; once dried, immediately remove fabrics and place on a clothes hanger.	
	EASY IRON PLUS <i>GE-MAKKELIJK STRIJKEN PLUS</i>	1 kg (or 5 shirts)	•	•	• 3)	•	-	•	-	•	Special program with anti-crease mechanism for easy care fabrics such shirts and blouses; for minimum ironing effort. The results depends on the type of fabric and its finish. Place fabrics in the dryer straight after spinning; once dried, immediately remove fabrics and place on a clothes hanger.	
	SHOES RACK <i>SPORTS-CHOENEN</i>	1 kg	-	-	• 3)	-	-	•	•	•	For gentle drying of one pair of sport shoes, washed and spin-dried at 1000 rpm. Programme run times: between 30 and 180 minutes.	

Programmes		max. load (weight when dry)	Additional functions/options							Application/properties	Care mark	
			DRYNESS DROOGTEGRAAD	RPM T/MIN	DELICATE 1)	LONG ANTI-CREASE	SENSITIVE 1)	BUZZER	TIME TIJD PROGR.			DELAY START STARTUITSTEL
WOOL RACK	DROOGREK WOL	1 kg	-	-	• 3)	-	-	•	•	•	For drying woollen fabrics after they have been washed, using warm air at minimum mechanical load (Follow section "Sorting and preparing washing"). Recommendation: Remove fabrics immediately after drying, as no anti-crease programme follows. Programme run times: between 30 and 180 minutes.	

- 1) DELICATE and SENSITIVE cannot be selected together
- 2) select DELICATE
- 3) set by default

Daily use

Switching machine on / switching light on

Turn the programme selector to any programme or turn it to LIGHT *LICHT AAN*. The machine has been switched on. When the loading door is opened, the drum is illuminated.

Opening loading door / loading laundry

1. Open loading door:
Use force to push against the loading door (push point)
2. Load your laundry (do not force it in).

CAUTION!

Do not jam laundry in between the loading door and rubber seal.

3. Close loading door securely. Lock must audibly lock.

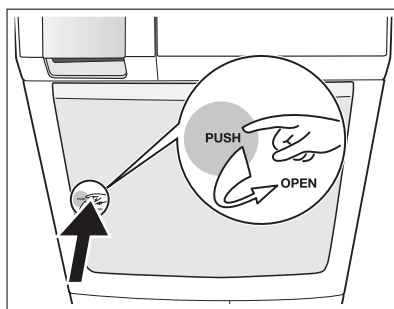

Selecting the programme

Use the programme selector to set the programme you require. The estimated time to end of the programme appears in the LCD in h:mm format (hours:minutes).

During the cycle time elapses by steps of one minute; less than 1 hour the leading zeros are not shown (ex. "59", "5", "0").

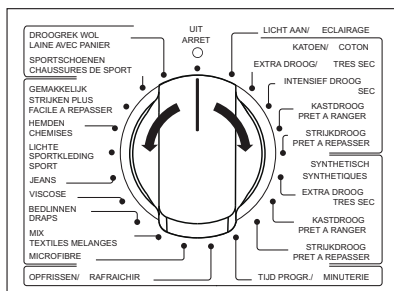

Setting dryness level

If laundry comes out of the machine too damp after a standard drying programme, you can increase the drying result by using the DRYNESS *DROOGTEGRAAD* function. Laundry becomes drier as you move from **MIN** to **MAX**.

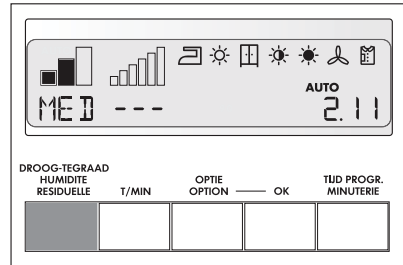

Press the DRYNESS *DROOGTEGRAAD* button repeatedly until the desired dryness level (**MIN**, **MED** or **MAX**) is shown in the display. When humidity adjustment is not foreseen on the related program, bar frame with **AUTO** text is shown.

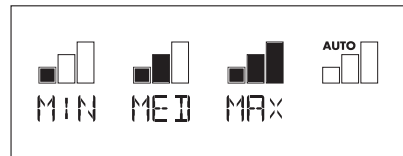

Setting the pre-drainage spin speed

If the washing in the washing machine was initially drained prior to the drying cycle, the dryer can be set according to the spin speed of the initial drainage procedure. The higher the spin speed was, the shorter the programme length for the drying cycle.

Press the RPM *T/MIN* button a number of times until the desired spin speed of the initial drainage is displayed. No value is shown if no spin speed is selected.

In certain programmes the spin speed has not effect (time controlled cycles), its selection can be not selectable and only three dashes are visualized. Available selections:

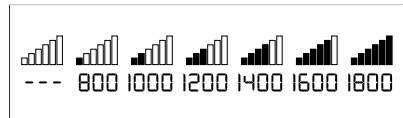
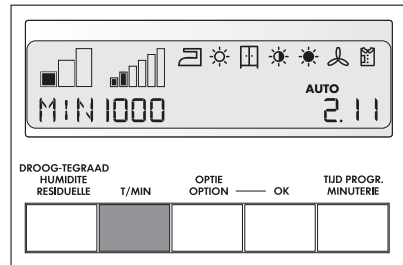

Selecting additional options

The additional options available for the drying programmes are DELICATE, LONG ANTI-CREASE, SENSITIVE and BUZZER

1. By turning the knob choose a drying programme.

- To set the option press **OPTION OPTIE** button. You will see available options shown as icons on the screen:

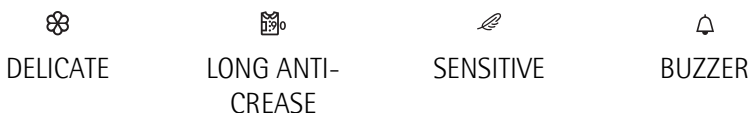

- ✿ DELICATE icon flashes. Flashing icon means: selected but not active. To activate selected **OPTION OPTIE** press **OK** button. Activated option is visible as flashing icon with dash beneath.
- Press alternately **OPTION OPTIE** button to select appropriate options an **OK** button to activate it. Active options are always on as icons with dash beneath.
- Option selection mode is finished when you go through all of them or you stop selecting. Only activated option icons are on.

i Some options cannot be selected together as DELICATE and SENSITIVE. Some of them are not selectable with certain programmes.

i To deselect an option follow the same steps. Option icon should disappear.

DELICATE

For especially gentle drying of sensitive fabrics with the  care label and for temperature-sensitive textiles (e.g. acrylic, viscose). Programme is executed with reduced heat.

DELICATE is only suitable for use with loads of up to 3kg.

When the option is active, the DELICATE  icon is on.

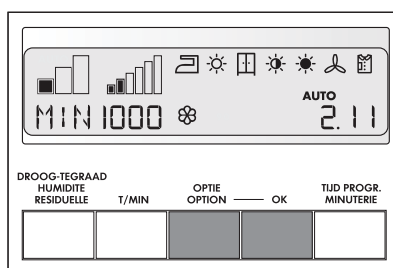

LONG ANTI-CREASE

A long anti-crease phase lengthen the anti-crease phase (30 min.) at the end of the drying additionally by 60 minutes. The drum rotates at intervals during this phase. This keeps the laundry loose and free of creases. Phase lasts in total 90 minutes. The laundry can be removed at any time during the anti-crease phase.

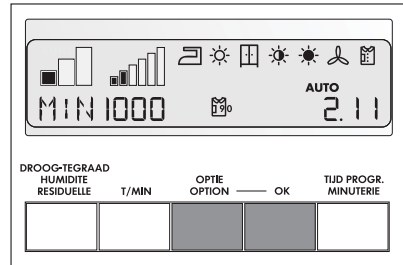

When the option is active, the LONG ANTI-CREASE  icon is on.

SENSITIVE

For gentle drying of fabrics that are frequently worn. Programme starts on full heat setting, which is then reduced as the programme progresses to be kind to the washing.

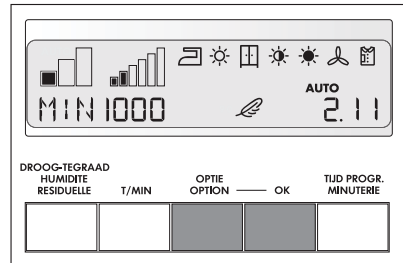

When the option is active, the SENSITIVE  icon is on.

BUZZER

The appliance is supplied with the BUZZER function deactivated.

To activate buzzer choose BUZZER option.

When the option is active, the BUZZER  icon is on.

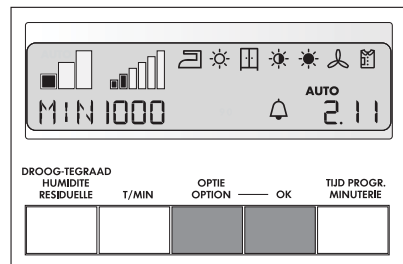

The buzzer sounds or plays a tune during:

- cycle end
- anti-crease phase and when phase starts or ends
- cycle interruption by a warning
- alarm

Time

To select the programme duration after setting the TIME *TIJD PROGR.* programme. You can select a programme duration from 10 mins to 3 hrs in 10-minute steps.

1. Turn the programme knob to the TIME *TIJD PROGR.* programme. The blinking 10' above TIME *TIJD PROGR.* button is on.
2. Press the TIME *TIJD PROGR.* button repeatedly until the desired programme duration is shown in the display, e.g. 20 for a programme of 20 minutes.

If the programme duration is not selected, the duration is automatically set to 10 mins.

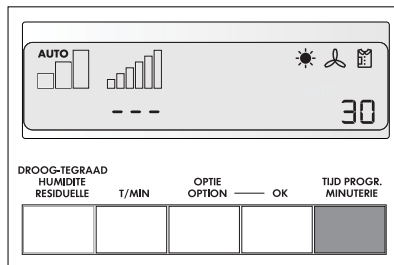

Setting delay timer

i With the DELAY *STARTUITSTEL* button, you can delay the start of a programme by between 30 minutes (30') and a maximum of 20 hours (20h).

1. Select the programme and additional functions.
2. Press the DELAY *STARTUITSTEL* button as many times as necessary until the required start delay appears on the display, e.g. 12h if the programme is to be started in 12 hours.

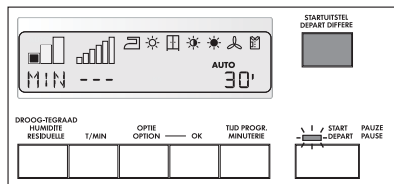

i If the display is showing 20h and you press the button again, the time delay will be cancelled. The display will show 0'and then the duration of the selected programme.

3. To activate the delay timer, press the START PAUZE *START PAUZE* button. The amount of time remaining until the programme is set to start is continuously displayed (e.g. 15h, 14h, 13h, ... 30' etc).

Setting child lock

The child lock can be set to prevent a programme being accidentally started or a programme in operation being accidentally changed. The child lock function locks

all buttons and the programme knob. The child lock can be activated or deactivated by holding down the *OPTION OPTIE* and *OK* buttons simultaneously for 5 seconds.



- Before programme is started: Appliance cannot be used
- After programme is started: Programme in operation cannot be changed

The  icon appears in the display to indicate that the child safety device is activated.







The child safety device is not deactivated once the programme comes to an end.

If you want to set a new programme, you must first deactivate the child safety device.

Starting the programme

Press the *START PAUSE START PAUZE* button.

The programme is started.

The programme progress is shown in LCD by appropriate set of icons. From left to the right, from *IRON DRY*  to *ANTI-CREASE*  icon depends on the drying cycle chosen. E. g. in case of *CUPBOARD* programme the following status icons are visible:     .

Current cycle progress is marked by flashing dash under status icon. When appropriate part of drying cycle is accomplished dash becomes steady and appears flashing under next status icon.

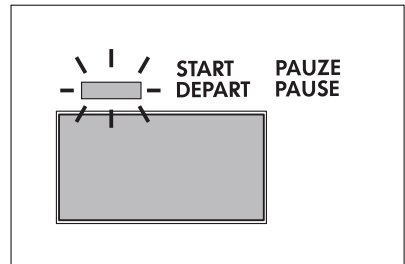

Changing programme

To change a programme which has been selected by mistake once the programme has started, first turn the programme selector to *OFF UIT* and then reset the programme.



The programme can no longer be changed directly once the programme has started. If nevertheless there is an attempt to change the programme on the programme knob, the programme progress display and the maintenance indicators flash. If an option button (excluding the *BUZZER* option) is pressed, **Err** appears in the multi-display. The drying programme is not however affected by this (laundry protection).

Putting in extra items or taking items out before end of programme

1. Open loading door.



WARNING!

Laundry and drum can become hot. **Risk of burns!**

2. Load or remove laundry items.
3. Close loading securely. Lock must audibly lock.
4. Press the START PAUSE *START PAUZE* button to continue the drying cycle.

Drying cycle complete / removing laundry

Once the drying cycle is complete, display shows a blinking "0", under anti-crease  icon appear dash. If the BUZZER *ZOEMER* option has been chosen, an acoustic signal sounds intermittently for about one minute.



The drying cycles (except for the SHOES RACK and WOOL RACK programmes) are automatically followed by an anti-crease phase which lasts around 30 minutes. The drum rotates at intervals during this phase. This keeps the laundry loose and free of creases. The laundry can be removed at any time during the anti-crease phase. (The laundry should be taken out towards the end of the anti-crease phase at the latest to prevent creases from forming.) If LONG ANTI-CREASE  function has been selected, the anti-crease phase is lengthened by 60 minutes.

1. Open door.
2. Before removing the laundry, remove fluff from the micro-fine filter. It is best to use a damp hand for this purpose. (See "Care and cleaning" chapter.)
3. Remove laundry.
4. Turn the programme selector to OFF *UIT*.



After each drying cycle:

- Clean the micro-fine filter and fine filter
 - Drain the condensed water container
- (See chapter "Care and cleaning".)

5. Close the door.

Drying rack

The drying rack offers the possibility of drying washable woollen fabrics and sports shoes. The drying rack does not turn with the clothes-dryer drum. This allows the drying of woollen garments or sports shoes.

When wet, the wool must be moved as little as possible because it tends to become matted, so drying rack is a solution.

Sports shoes cannot be dry without rack otherwise can damage the drum due to their weight.



For first unpacking of the rack please refer to the installation chapter.



WARNING!

Before installing the rack check the dryer drum. It must be empty!

1. Open the loading door.
2. Insert the rack.

Lift the rack horizontally in the drum.
Guide the rack down until the support bracket at the front rests on the opening.

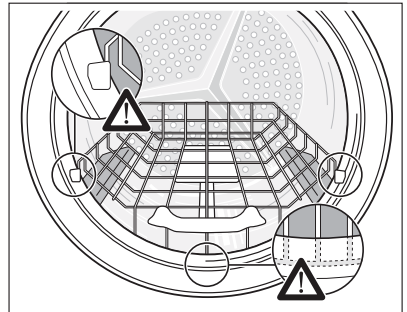

3. Place the washing on the rack:
 - Spread the garment out in the rack and roll it up, without squashing or folding it.
 - Place sport shoes on the rack with the handle turned up as a support.

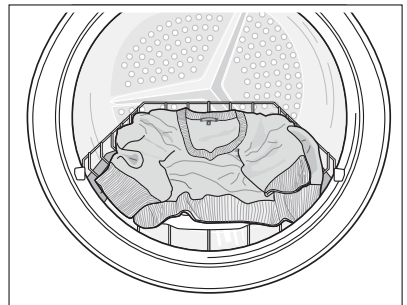



Take out the insoles and place them beside the shoes on the rack. Tie the shoelaces.

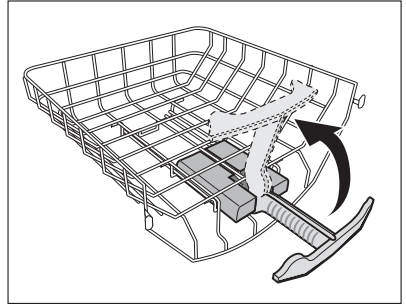

4. Select the required programme run time, selectable with an interval of 10 min, from 30 min. up to 180 minutes. Press the *TIME TIJD PROGR.* button as many times as necessary until the required programme running time is shown in the display.
5. Press the *START PAUSE START PAUZE* button. The programme is started.
6. At the end of the drying programme open the loading door and remove the garments or shoes.
7. Turn the programme selector to *OFF UIT.*
8. Remove the rack from the drum at the end of drying.

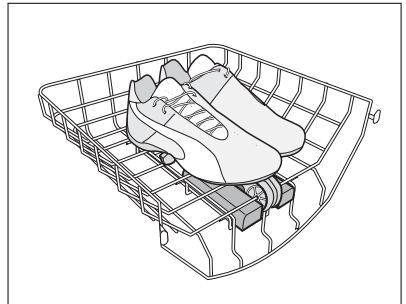

Care and cleaning

Cleaning fluff filter

The filters collect all the fluff which accumulates during drying. To ensure that the dryer works perfectly, the fluff filters (micro-fine filter and fine strainer) must be cleaned after every drying cycle.

The warning icon  is on to remind you this operation.



CAUTION!

Never operate the dryer without fluff filters or with damaged or blocked fluff filters.

1. Open loading door
2. Use a damp hand to clean the micro-fine filter, which is built into the lower part of the loading aperture.

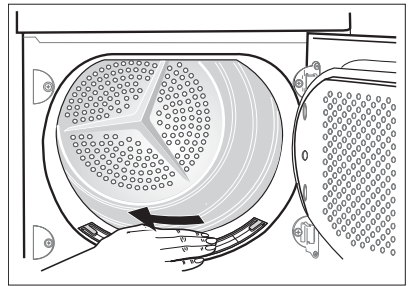

3. After a period of time, a patina due to detergent residue on laundry forms on the filters. When this occurs, clean the filters with warm water using a brush. Remove the filter from the door pulling it out. It can be positioned with the tooth facing to the left or to the right).

After cleaning do not forget to put it back.

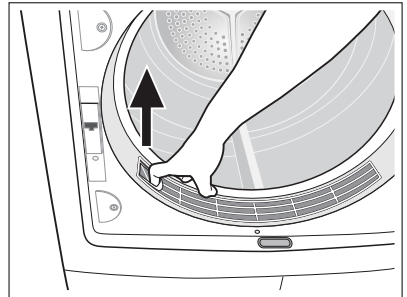

4. Push down unlock button on large mesh filter.
Large mesh filter jumps up.

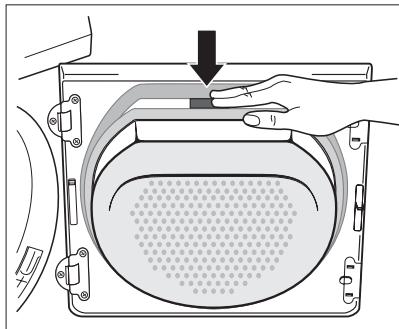

5. Take out fine strainer.
6. Remove fluff from fine strainer. It is best to use a damp hand for this purpose.

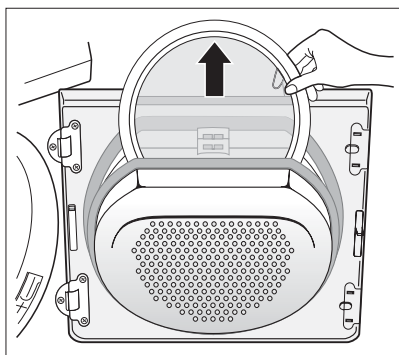

i **Clean the entire filter area**

The strainer area does not have to be cleaned after every drying cycle, but should be checked regularly and cleaned of fluff if necessary.

7. To do this, grip the top of the large mesh filter and pull it forwards until it comes loose from the two brackets.
8. Remove fluff from the entire filter area. It is best to use a vacuum cleaner for this purpose.
9. Press both journals of the large mesh filter into the brackets on the loading door until they snap into place.
10. Re-insert fine strainer.
11. Press against the large mesh filter until it locks into the interlock.

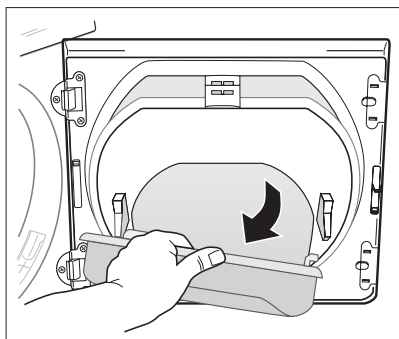



If the fine strainer is not fitted, the large mesh filter will not snap into place and the loading door cannot be closed.

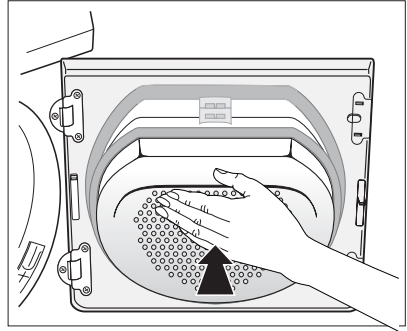

Cleaning the door seal

Wipe the door seal with a damp cloth immediately after the drying cycle has finished.

Emptying the condensate tank

Empty condensate tank after every drying cycle.

If the condensate tank is full, an active programme will break off automatically and the EMPTY CONTAINER  icon on the display will light up. In order to continue the programme, the condensate tank must first be emptied.



WARNING!

The condensate is not suitable for drinking or for preparing foodstuffs.

1. Take out drawer containing condensed water container completely **1** and pull up the condensed water container's drainage pipe as far as it will go **2**.

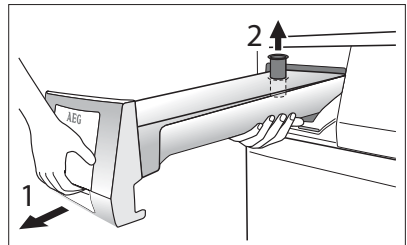

2. Pour condensed water out into a basin or similar receptacle.
3. Slide outlet connections in and refit condensate tank.

If the programme has been interrupted as a result of the condensate tank being full: Press the **START PAUSE** **START PAUZE** button to continue the drying cycle.

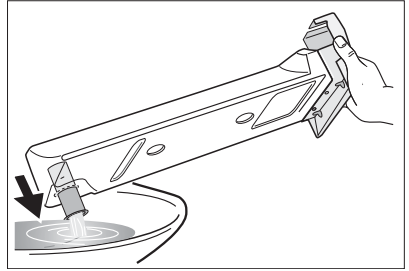

- i** The condensate tank has a volume of approx. 4 litres. This is sufficient for around 7 kg of laundry which has previously been spun at 1000 revolutions/ minute.
- i** The condensate can be used as distilled water, e.g. for steam ironing. However first filter the condensate (e.g. with a coffee filter) to remove any residue and small pieces of fluff.

Cleaning heat exchanger

If the **HEAT EXCHANGER** \Rightarrow is displayed, the heat exchanger needs to be cleaned.



CAUTION!

Operating when the heat exchanger is blocked with fluff can damage the dryer. This also increases energy consumption.

1. Open door.
2. Open door in plinth. To do this, press the release button on the bottom of the door aperture and open the door in the plinth to the left.
3. Clean fluff from the inside of the door and the heat exchanger front chamber. Wipe the door seal with a damp cloth.

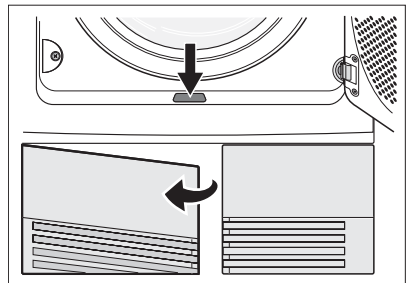

4. Turn both lock washers inwards.

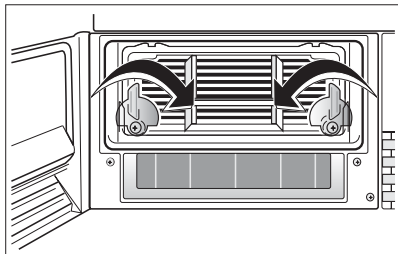

5. Use the handle to pull the heat exchanger out of the base and carry it horizontally to prevent any remaining water from spilling.
6. To empty the heat exchanger, hold vertically over a washing-up bowl.

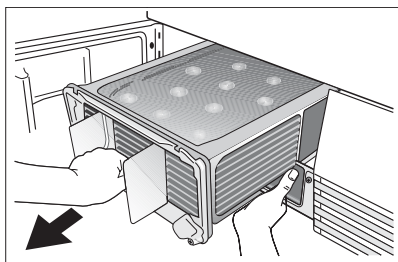
**CAUTION!**

Do not use sharp objects to clean. The heat exchanger could develop leaks.

7. Clean heat exchanger.

It is best to use a brush or to rinse thoroughly with a hand-held shower.

8. Replace heat exchanger and lock into place (turn both lock washers outwards until they snap into place).
9. Close door in plinth.

**CAUTION!**

Never operate the dryer without the heat exchanger.

Cleaning the drum

**CAUTION!**

Do not use abrasives or steel wool to clean the drum.



Lime in the water or cleaning agents may form a barely visible lining on the inside of the drum. The degree to which the laundry has been dried is then no longer detected reliably. The laundry is damper than expected when removed from the dryer.

Use a standard domestic cleaner (e.g. vinegar-based cleaner) to wipe down the inside of the drum and drum ribs.

Clean operating screen and housing



CAUTION!

Do not use furniture cleaners or aggressive cleaning agents to clean the machine. Use a damp cloth to wipe down the operating screen and housing.

What to do if ...

Troubleshooting by yourself

If, during operation, the error code **E...** (plus number or letter) appears on the LCD: Switch the machine off and on again. Reset programme. Press the START PAUSE *START PAUZE* button. If the error is still displayed, please inform your local Service Force Centre and quote the error code.

Problem	Possible cause	Remedy
Dryer does not work.	Mains plug is not plugged in or fuse is not working correctly.	Plug in at mains socket. Check fuse in fuse box (domestic installation).
	Loading door is open.	Close loading door.
	Have you pressed the START PAUSE <i>START PAUZE</i> button?	Press the START PAUSE <i>START PAUZE</i> button again.
Drying results unsatisfactory.	Wrong programme selected.	Select a different programme the next time you dry (see "Programme chart" chapter).
	Lint filters clogged.	Clean lint filters.
	Fluff filter clogged.	Clean fluff filter.
	Heat exchanger clogged with lint.	Clean heat exchanger.
	Overloading of laundry.	Observe recommended loading volumes.
	Ventilation slots in base area covered up.	Uncover ventilation slots in base area.
	Residue on inside surface of drum or drum ribs.	Clean inside surface of drum and drum ribs. Make an adjustment using the DRYNESS <i>DROOGTEGRAAD</i> function (see chapter "Daily use")
Conductance of water at installation site differs from standard setting of machine.	Re-programme standard setting for degree of drying (see 'Programming options' chapter).	
Loading door does not close.	Fine strainer not in place and/or mesh filter not locked in place.	Install fine strainer and/or snap large mesh filter into place.
When a button is pressed, Err appears on the LCD.	Washing protection. After the start of the programme, the option can no longer be set.	Turn the programme knob to OFF <i>UIT</i> . Set the programme again.

Drum light does not work.	Programme selector in OFF <i>UIT</i> position.	Turn programme selector to LIGHT <i>LICHT AAN</i> or to any programme.
	Defective light bulb.	Replace light bulb (see next section).
Displayed programme time changes erratically or stays unchanged for a long time.	Programme time is corrected automatically depending on type and volume of laundry and level of dampness.	Automatic process; this is not a machine fault.
Programme inactive, empty water tank  icon is on.	Condensate tank is full.	Empty condensate tank, then start programme with START PAUSE <i>START PAUZE</i> button.
Drying cycle ends shortly after programme starts.	Not enough washing loaded or washing loaded is too dry for selected programme.	Select time programme or higher drying level (e.g. INTENSIVE DRY <i>INTENSIEFDROOG</i> instead of STORAGE DRY <i>KASTDROOG</i>).
Drying cycle lasts an unusually long time. Note: After around 5 hours the drying cycle ends automatically (see „Drying cycle complete“).	Lint filter clogged.	Clean lint filter.
	Fluff filter clogged.	Clean fluff filter.
	Load volume too big.	Reduce load volume.
	Laundry insufficiently spun.	Laundry must be adequately spun.
	Particularly high room temperature. Temporary switching off of the compressor to avoid overload.	Automatic process, there is no fault with the appliance. If possible, lower the room temperature.

Changing the bulb for interior lighting

Only use a special bulb which is designed specially for dryers. The special bulb can be obtained from the Customer Care Department, ET no. 112 552 000-5.



When the appliance is switched on, the interior lighting switches itself off after 4 minutes when the door is open.



WARNING!

Do not use standard bulbs! These develop too much heat and may damage the machine!



WARNING!

Before replacing the bulb, disconnect the mains plug.

1. Unscrew cover above the bulb (this can be found directly behind the loading aperture, at the top; refer to "Description of machine" section.)
2. Replace defective bulb.
3. Screw cover back down.











Check the correct positioning of o-ring gasket before screwing back the door light cover. Do not operate the dryer when missing o-ring gasket on door light cover.



WARNING!

For safety reasons, the cover must be screwed down tightly. If this is not done, the dryer must not be operated.

Machine settings

Setting	Implementation
BUZZER permanent off	<ol style="list-style-type: none"> 1. Turn the programme selector to any programme. 2. Press simultaneously the DRYNESS <i>DROOGTEGRAAD</i> and RPM <i>T/MIN</i> buttons and hold down for approx. 5 seconds. 3. The buzzer is by default always off. You can use BUZZER option to activate or deactivate sound but machine does not memorize your selection.
<div data-bbox="72 528 117 571" style="float: left; margin-right: 10px;">  </div> <p><i>Water contains, a variable quantity of limestone and mineral salts of which quantities vary according to geographical locations thus varying its conductivity values.</i></p> <p><i>Relevant variations of the conductivity of the water compared to those prefixed by the factory could slightly influence the residual humidity of the laundry at the end of the cycle. Your dryer allows you to regulate the sensitivity of the drying sensor based on conductivity values of the water.</i></p>	<ol style="list-style-type: none"> 1. Turn the programme selector to any programme. 2. Press simultaneously the DRYNESS <i>DROOGTEGRAAD</i> and TIME <i>TIJD PROGR.</i> buttons and hold down for approx. 5 seconds. The current setting is on the display: <ul style="list-style-type: none"> -  low conductivity <300 micro S/cm -  medium conductivity 300-600 micro S/cm -  high conductivity >600 micro S/cm 3. Press the START PAUSE <i>START PAUZE</i> button sequentially until you set desired level. 4. To memorize setting press simultaneously the DRYNESS <i>DROOGTEGRAAD</i> and TIME <i>TIJD PROGR.</i> buttons or turn knob to OFF <i>UIT</i> position
<div data-bbox="72 1029 117 1072" style="float: left; margin-right: 10px;">  </div> <p>Emptying water tank – warning message permanent off</p> <p><i>When using an external drain for the condensed water.</i></p> <div data-bbox="414 1236 459 1279" style="float: right; margin-top: 20px;">  </div>	<ol style="list-style-type: none"> 1. Turn the programme selector to any programme. 2. Press simultaneously the RPM <i>T/MIN</i> and TIME <i>TIJD PROGR.</i> buttons and hold down for approx. 5 seconds. The current setting is on the display: <ul style="list-style-type: none"> - warning  icon and  - warning message is off - warning  icon and  - warning message is switched on <p>By default the warning message is switched on and displayed always at the end of the drying cycle or during the cycle if the water container is full.</p>

Technical data



This appliance conforms with the following EU Directives:

- 73/23/EEC dated 19.02.1973 Low Voltage Directive
- 89/336/EEC dated 03.05.1989 EMC Directive inclusive of Amending Directive 92/31/EEC
- 93/68/EEC dated 22.07.1993 CE Marking Directive

Height x width x depth	85 x 60 x 58 cm
Depth with loading door open	109 cm
Height can be adjusted by	1.5 cm
Weight when empty	approx. 40 kg
Loading volume (depends on programme) ¹⁾	max. 7kg
Energy consumption in accordance with IEC 61121 s. e. (7kg of cotton, pre-drained at 1000 rpm, COTTON CUPBOARD DRY KATOEN KASTDROOG programme)	3,92 kWh
Use	Domestic
Permissible ambient temperature	+ 5°C to + 35°C

1) Different loading volume data may be needed in some countries as a result of different measuring methods.

Consumption values

The consumption values have been established under standard conditions. They may deviate when the machine is operated in domestic circumstances.

Programme	Loading volume in kg	Energy consumption in kWh
COTTON CUPBOARD DRY ¹⁾ KATOEN KASTDROOG	7	3.92
COTTON IRON DRY ¹⁾ KATOEN STRIJKDROOG	7	3.34
SYNTHETICS CUPBOARD DRY ²⁾ SYNTHETISCH KASTDROOG	3	1.33

1) pre-drained at 1000 rpm

2) pre-drained at 1200 rpm

Hints for test institutes

Parameters possible to checked by the Test Institutes:

- Energy consumption (corrected with final humidity) during the cupboard dry cotton cycle with nominal load.
- Energy consumption (corrected with final humidity) during the cupboard dry cotton cycle with half load.
- Final humidity (during Cupboard dry cotton, Iron dry cotton and Cupboard dry Easy care)
- Condensation efficiency (corrected with final humidity) during cupboard dry cotton cycle with nominal and half load

All the cycles have to be checked in accordance with IEC 61121 (Tumble dryers for household use – Methods for measuring the performance).

Installation

Appliance positioning

- It is recommended that, for your convenience, the machine is positioned close to your washing machine.
- The tumble dryer must be installed in a clean place, where dirt does not build up.
- Air must be able to circulate freely all round the appliance. Do not obstruct the front ventilation grille or the air intake grilles at the back of the machine.
- To keep vibration and noise to a minimum when the dryer is in use, it should be placed on a firm, level surface.
- Once in its permanent operating position, check that the dryer is absolutely level with the aid of a spirit level. If it is not, raise or lower the feet until it is.
- The feet must never be removed. Do not restrict the floor clearance through deeppile carpets, strips of wood or similar. This might cause heat built-up which would interfere with the operation of the appliance.



The hot air emitted by the tumble dryer can reach temperatures of up to 60°C. The appliance must therefore not be installed on floors which are not resistant to high temperatures.

When operating the tumble dryer, the room temperature must not be lower than +5°C and higher than +35°C, as it may affect the performance of the appliance.

**WARNING!**

Should the appliance be moved, it must be transported vertically.

**WARNING!**

The appliance must not be installed behind the lockable door, a sliding door or a door with a hinge on the opposite side to that of the appliance.

Removing transport safety packaging

**CAUTION!**

Before use all parts of the transport packaging must be removed.

1. Open loading door
2. Pull off adhesive strips from inside machine on top of drum.
3. Remove foil hose and polystyrene padding from the machine.

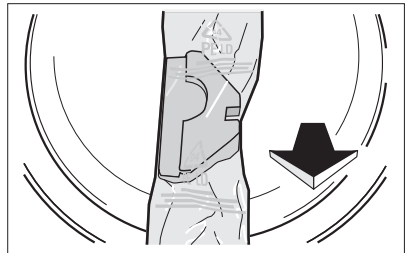
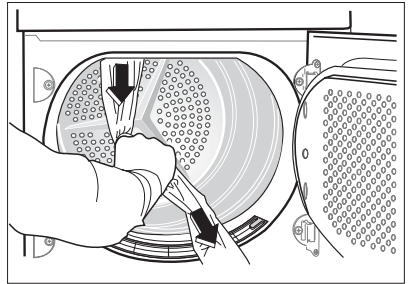

Drying rack unpacking

**CAUTION!**

Before use all packaging parts and rack must be removed from the drum

To unpack the rack:

1. Remove upper protection polystyrene parts by pulling them.
 2. Remove the elastic band fixing the rack handle to container.
3. Pull slightly rack handle (not to the end). Grasp at it harder and lift it up.
For easiest unpacking turn the rack upside down
 4. Take it carefully out of the drum.
 5. Remove from the drum rest of packing elements.

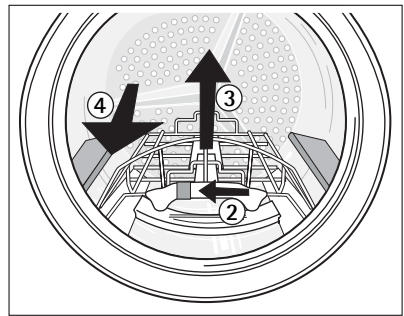
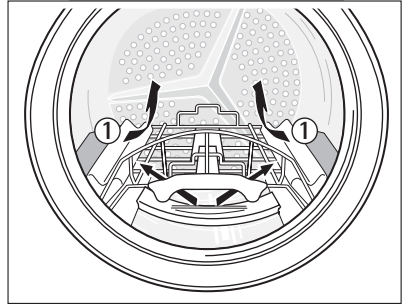

Electrical connection

Details on mains voltage, type of current and the fuses required should be taken from the type plate. The type plate is fitted near the loading aperture (see "Product description" chapter).



WARNING!

The manufacturer declines any responsibility for damage or injury through failure to comply with the above safety precautions.

Should the appliance power supply cable need to be replaced, this must be carried out by our Service Center.

The power supply cable must be accessible after installing the machine.

Connect the machine to an earthed socket, in accordance with current wiring regulations.

Changing door stop



WARNING!

The door stop may only be changed by a specialist. If necessary, please contact our after-sales service or your specialist dealer.



WARNING!

Before changing the door stop, disconnect the mains plug.

1. Open loading door.
2. Unscrew hinge **A** from the front of the machine and take off the loading door.
3. Remove cover plates **B** and **C**. To do this, insert a thin screwdriver into the slots as shown in the illustration, press downwards slightly and pry out the cover plates.
4. Use an appropriate tool and exert pressure to unfasten locking block **D** from the snap-on fixture, take out and re-insert on the other side having rotated the block through 180°.
5. Unscrew hinge **A** from the loading door, rotate through 180°, re-insert on the opposite side and screw down.
6. Re-insert cover plates **B** and **C** on the opposite site having first rotated them through 180°.

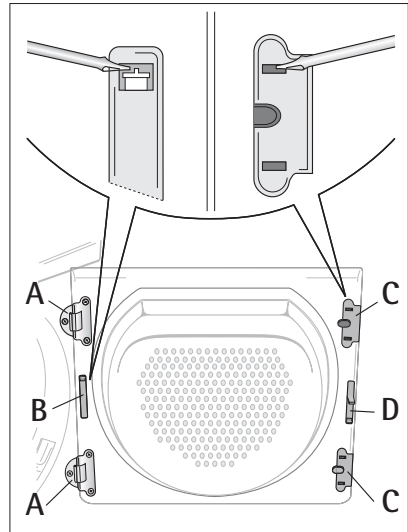

7. Unscrew cover plates **E** from the front of the machine, rotate through 180°, screw on the opposite side.
8. Unscrew door lock **F**, push down slightly and remove from the front of the machine.
9. Disconnect cable connector from door lock **F**.
10. Press snap-in button **G** in and down, press cover down slightly and remove from front of the machine.
11. Disconnect cable connector from cover **G**.
12. Change door lock **F** over to the opposite side, insert the cable connector and screw down the door interlock.
13. On the other side, insert the cable connector in cover **G**, insert cover and allow snap-in button to lock into place.
14. Insert loading door and hinges into recesses on the front of the machine and screw down.

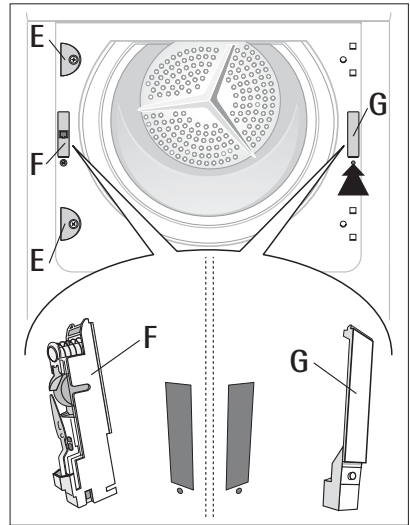

Note regarding contact protection: The machine is only secure for operations again once all plastic parts have been inserted.

Special accessories

Intermediate installation kit for stacked washer and dryer:



Available from your Service Force Centre or your specialist dealer

These intermediate installation kits can be used to arrange the dryer and an automatic AEG-Electrolux washing machine (60cm wide, front loading) as a space-saving washer/dryer stack. The automatic washing machine is at the bottom and the dryer is at the top.

Version to be supplied:

– with extractable stacker plate **916.018 903**

Read carefully the instructions supplied with the kit.

Installation kit for external condensate drain



Attached to your product

Installation kit **125 122 510** for direct draining of condensate into a basin, siphon, gully, etc. The condensate tank then no longer has to be drained, it must however remain in its intended position in the machine. Refer to the "Programme options" section for how to deactivate the EMPTY WATER TANK  alert.

Max. displacement height: 1m from the base of the dryer; max. displacement length: 3m

Read carefully the instructions supplied with the kit.

Environment

Packaging material

The packaging materials are environmentally friendly and can be recycled. The plastic components are identified by markings, e.g. >PE<, >PS<, etc. Please dispose of the packaging materials in the appropriate container at the community waste disposal facilities.

Old appliance

The symbol  on the product or on its packaging indicates that this product may not be treated as household waste. Instead it should be taken to the appropriate collection point for the recycling of electrical and electronic equipment. By ensuring this product is disposed of correctly, you will help prevent potential negative consequences for the environment and human health, which could otherwise be caused by inappropriate waste handling of this product. For more detailed information about recycling of this product, please contact your local council, your household waste disposal service or the shop where you purchased the product.



WARNING!

Remove mains plug from socket when you have no further use for the machine. Cut off mains cable and dispose of together with plug. Destroy loading door hook. Children cannot then lock themselves in the machine and put their lives at risk.

Environmental tips

- In the dryer, laundry becomes fluffy and soft. Fabric softeners are not therefore needed when washing.
- Your dryer will function most economically if you:
 - always keep the ventilation slots on the base of the dryer unobstructed;
 - use the loading volumes specified in the programme overview;
 - ensure you have good ventilation in the installation room;
 - clean the micro-fine filter and fine strainer after each drying cycle;
 - spin the laundry well before drying. Example: Consumption data – depending on spinning speed – for 7kg of laundry, dried using the COTTONS CUPBOARD DRY programme.

Revolutions per minute	Pre-draining		Drying cycle	
	Residual dampness		Energy in kWh	Costs in euros ¹⁾
	in litres	as a %		
1000	4.20	60	3,92	0,58
1200	3.92	56	3,75	0,56
1400	3.64	52	3,60	0,54
1800	3.15	45	3,20	0,48

1) Tariff: 0.15 Euro/kWh

Service

In the event of technical faults, please first check whether you can remedy the problem yourself with the help of the operating instructions (Chapter "What to do if...").

If you were not able to remedy the problem yourself, please contact the Customer Care Department or one of our service partners.

In order to be able to assist you quickly, we require the following information:

- Model description
- Product number (PNC)
- Serial number (S No.) (for numbers, see rating plate)
- Type of fault
- Any error messages displayed by the appliance

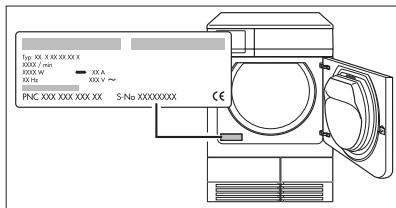

So that you have the necessary reference numbers from your appliance at hand, we recommend that you write them in here:

Model description:

PNC:

S No.:

www.electrolux.com



www.aeg-electrolux.co.uk

www.aeg-electrolux.be

Subject to change without notice

136900490-00-24092007